

# Comodo

Typ A12

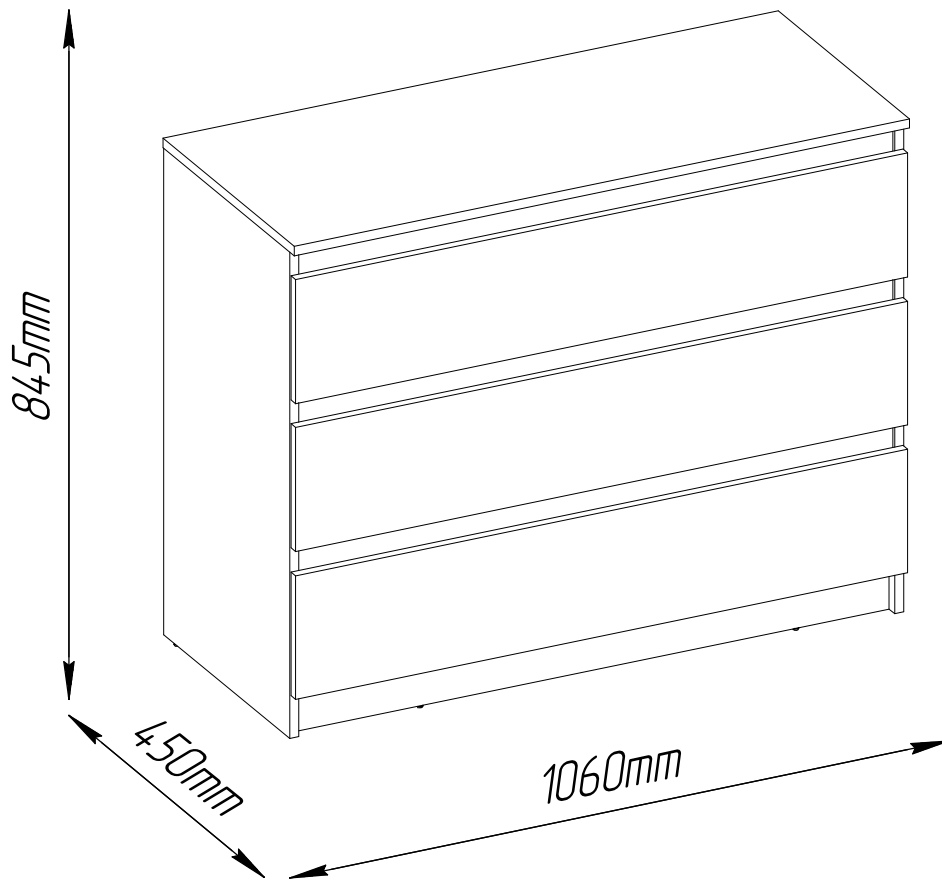

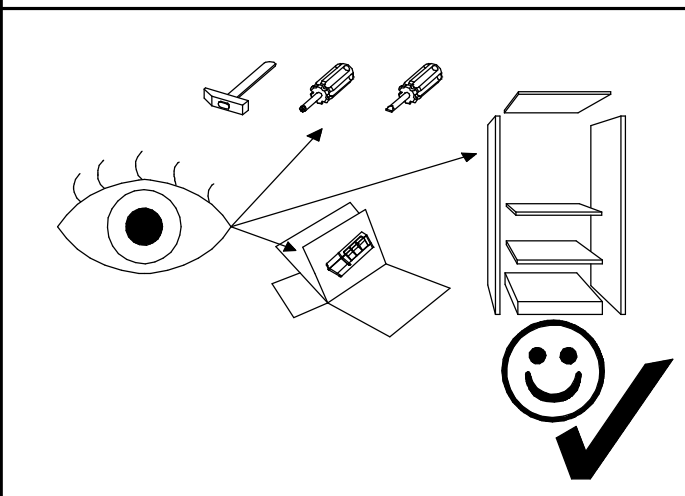

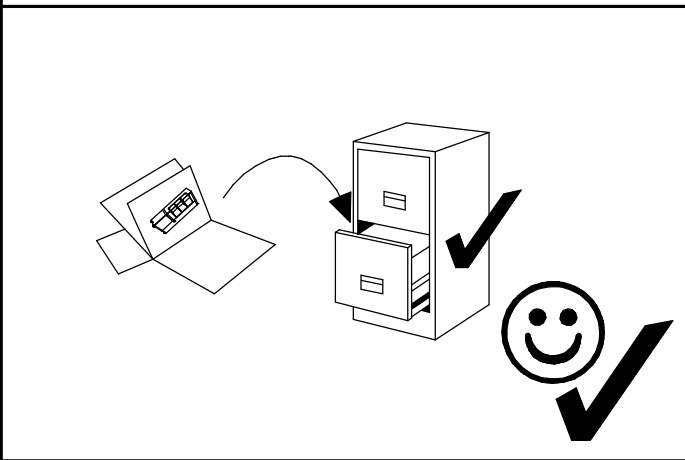
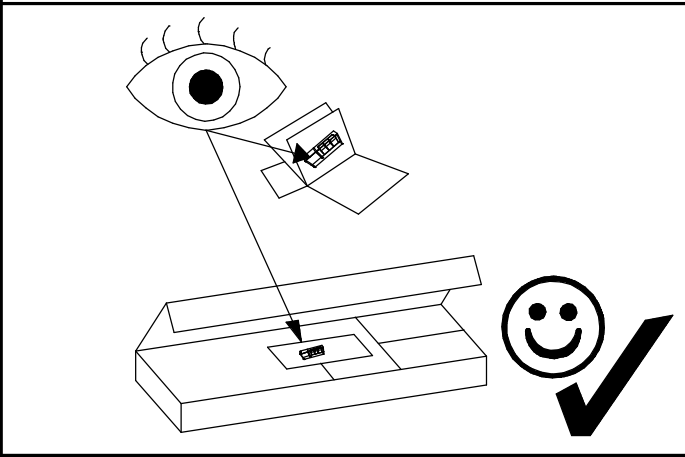
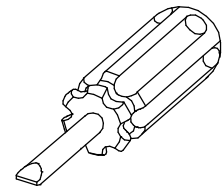
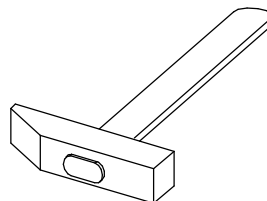
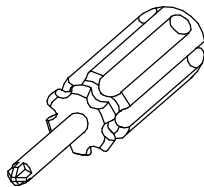
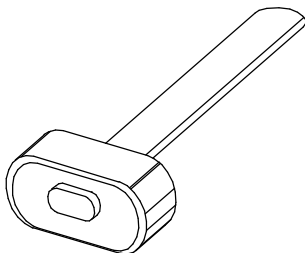
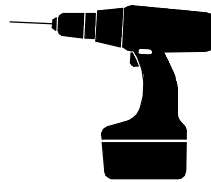
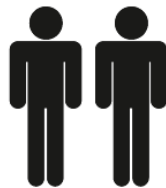
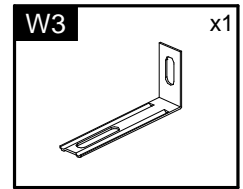
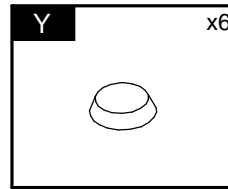
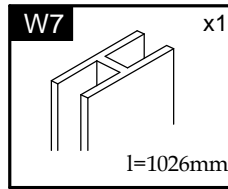
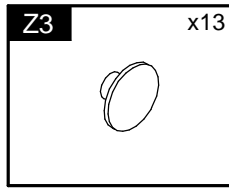
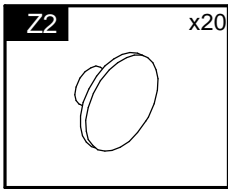
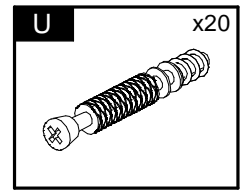
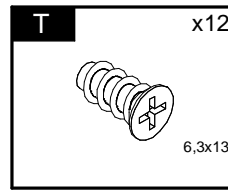
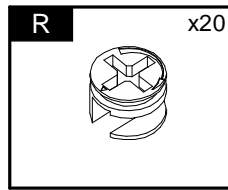
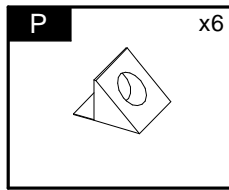
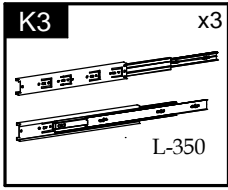
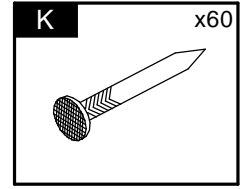
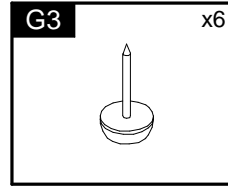
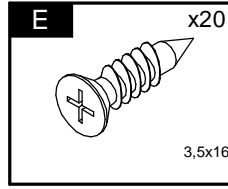
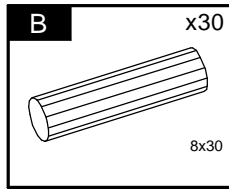
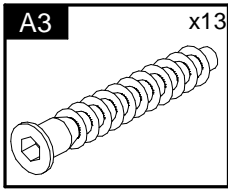
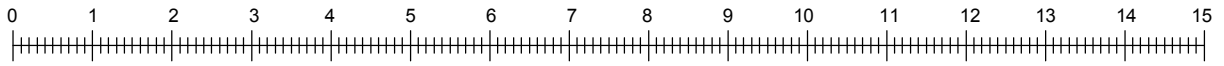

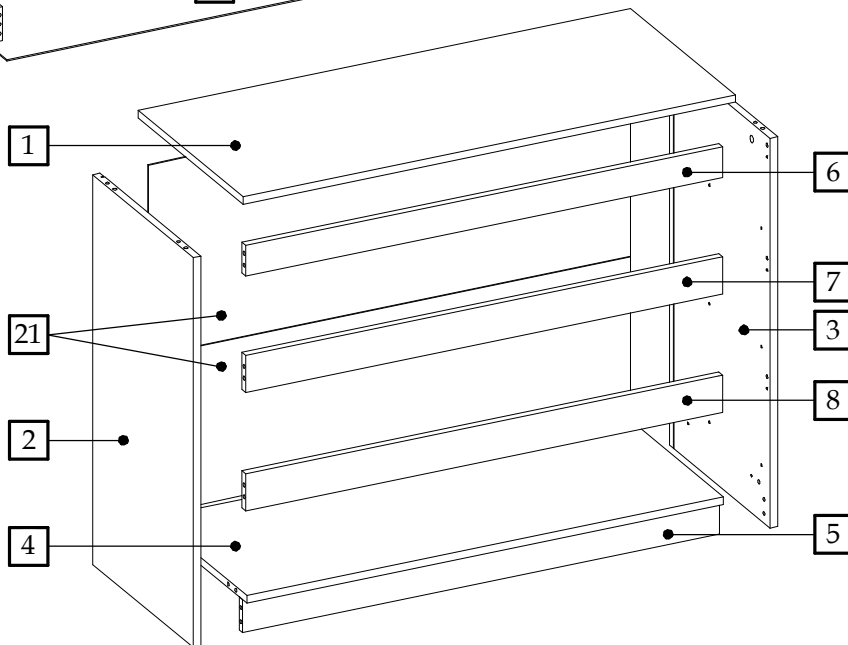
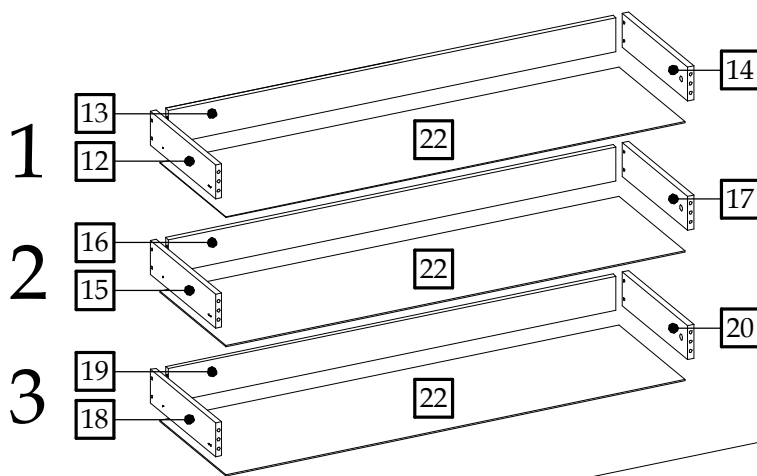
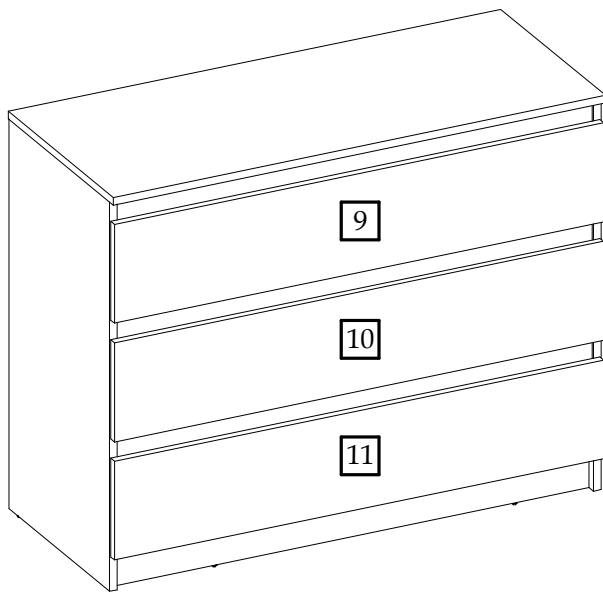

Element symbol	Measurements				Code
	mm	mm	mm	mm	
1	1060	450	16	1	1002
2	824	433	16	1	1003
3	824	433	16	1	1004
4	1026	412	16	1	1005
5	1026	70	16	1	1006
6	1026	65	16	1	1012
7	1026	65	16	1	1018
8	1026	65	16	1	1001
9	1054	209	16	1	1007
10	1054	209	16	1	1013
11	1054	209	16	1	1019
12	350	89,5	16	1	1008/2008
13	968,5	89,5	16	1	1009
14	350	89,5	16	1	1010/2010
15	350	89,5	16	1	1014/2014
16	968,5	89,5	16	1	1015
17	350	89,5	16	1	1016/2016
18	350	89,5	16	1	1020/2020
19	968,5	89,5	16	1	1021
20	350	89,5	16	1	1022/2022
21	1038	380	3	2	N/A
22	1005	355	3	3	N/A

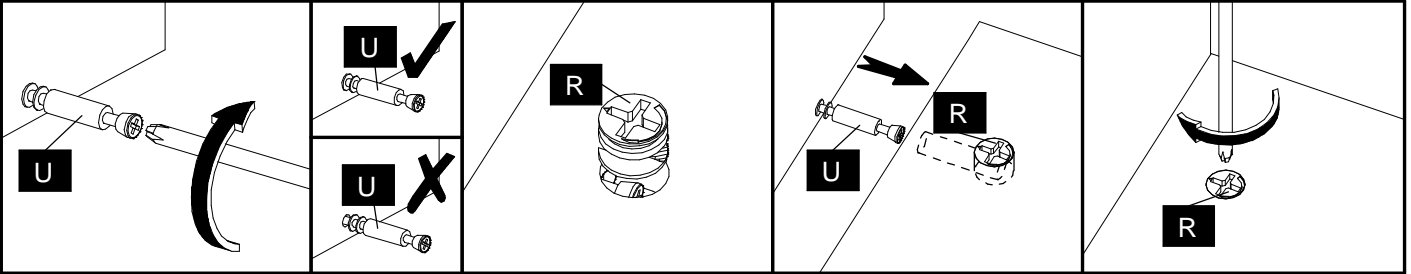

1

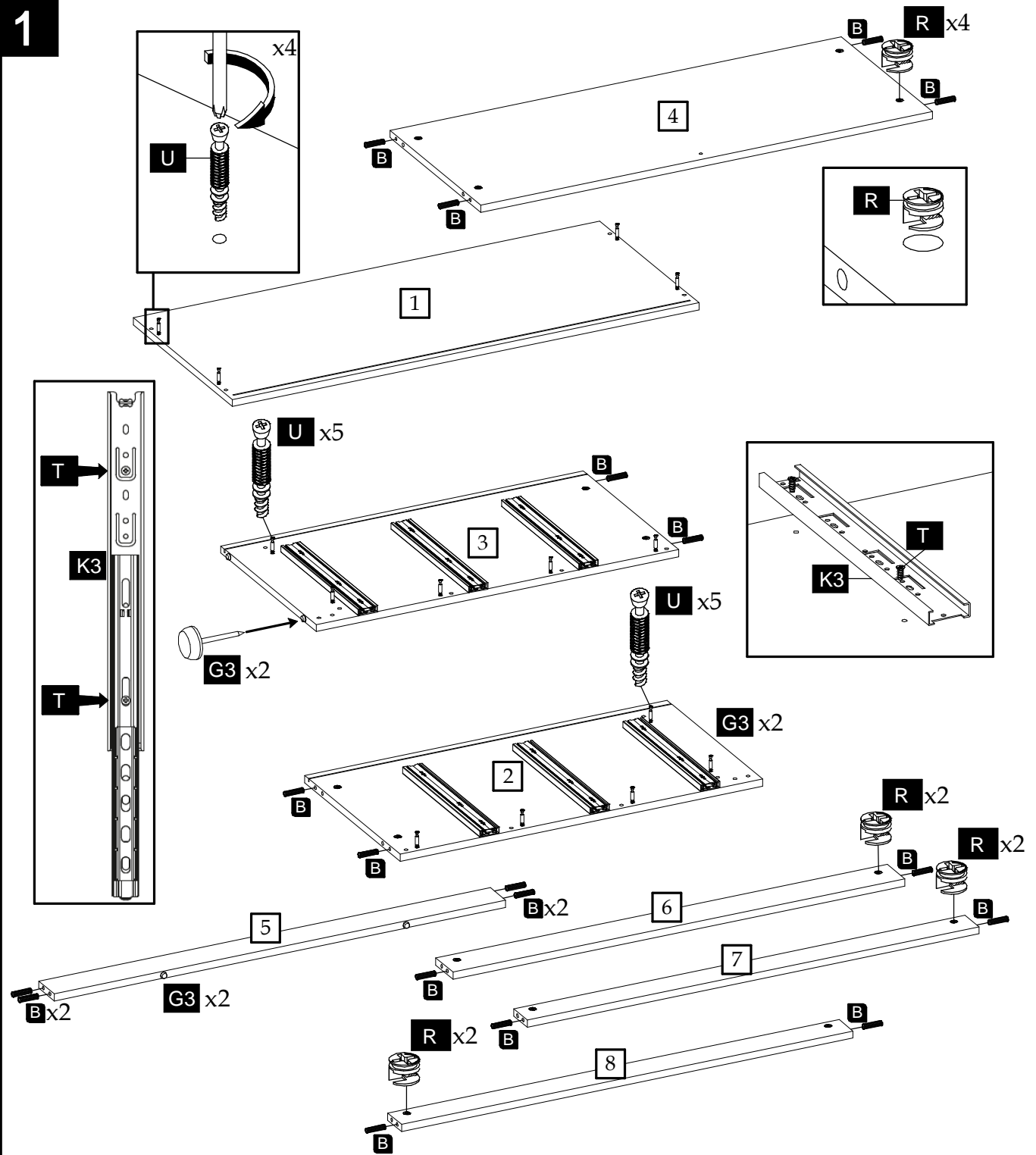

2

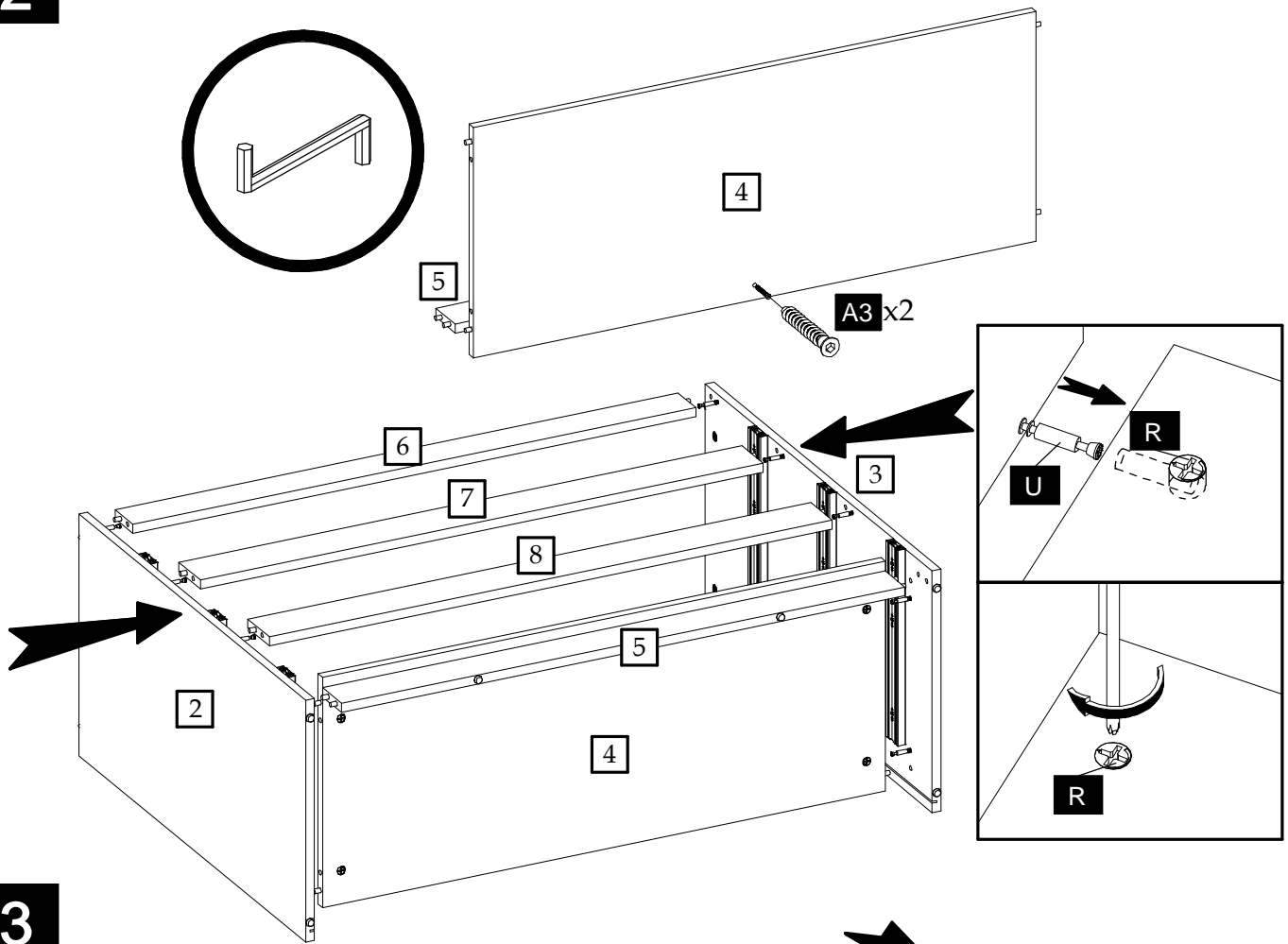

3

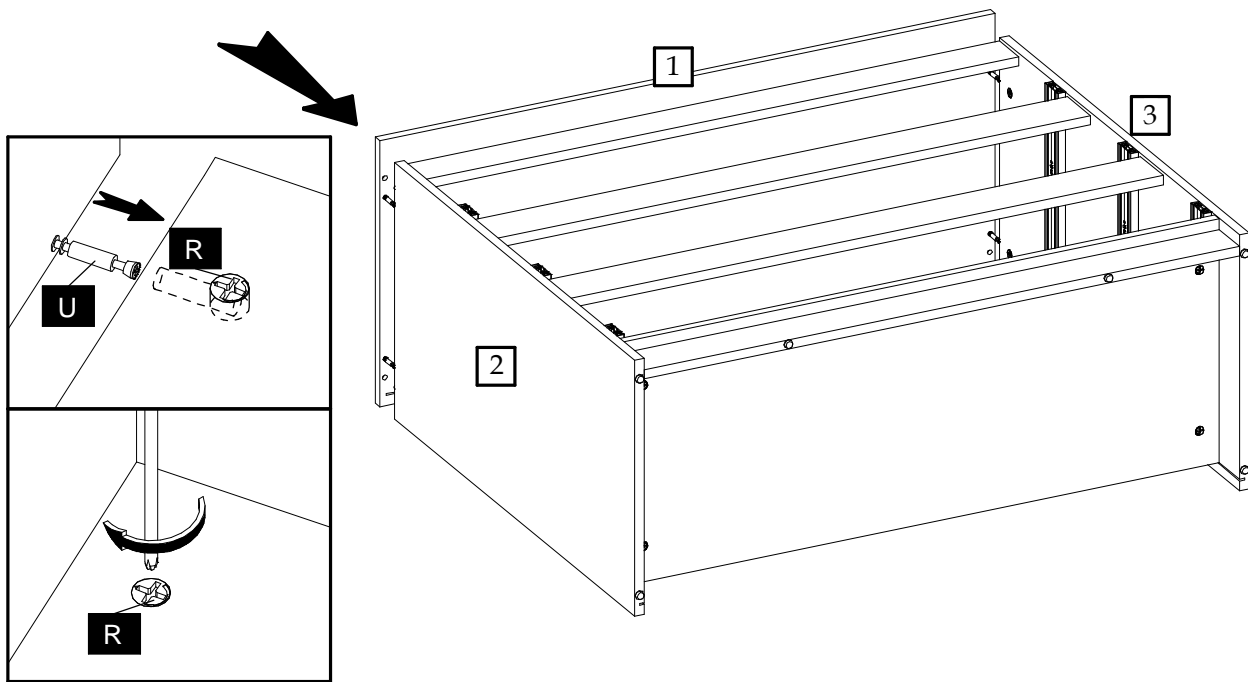

4

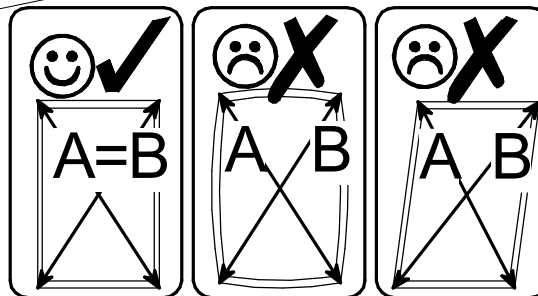
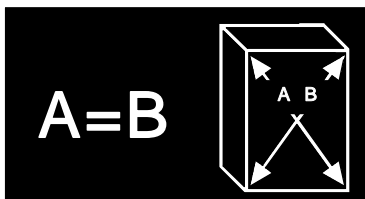
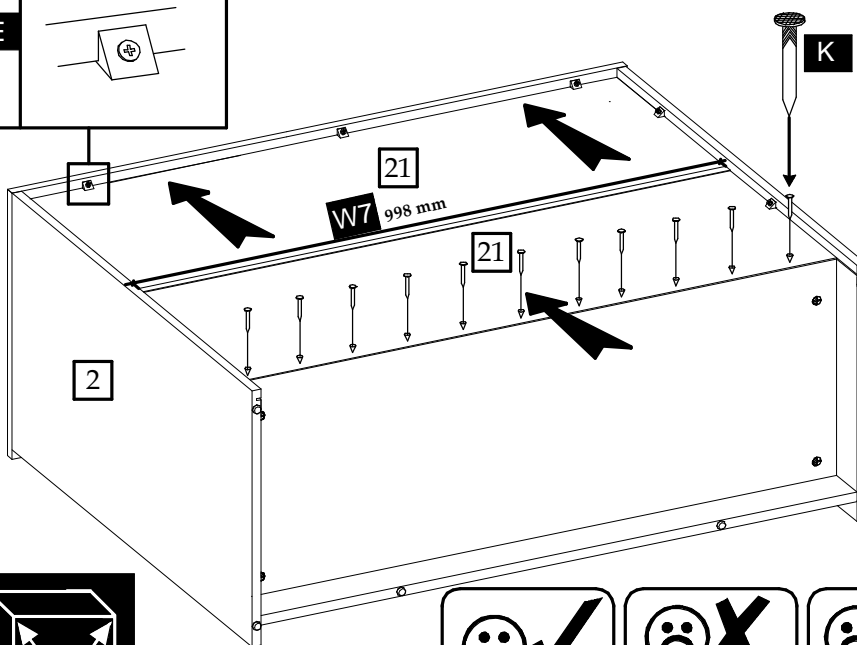
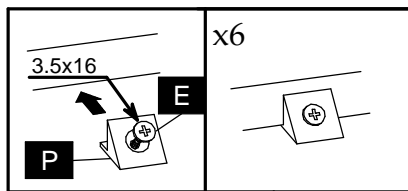

5

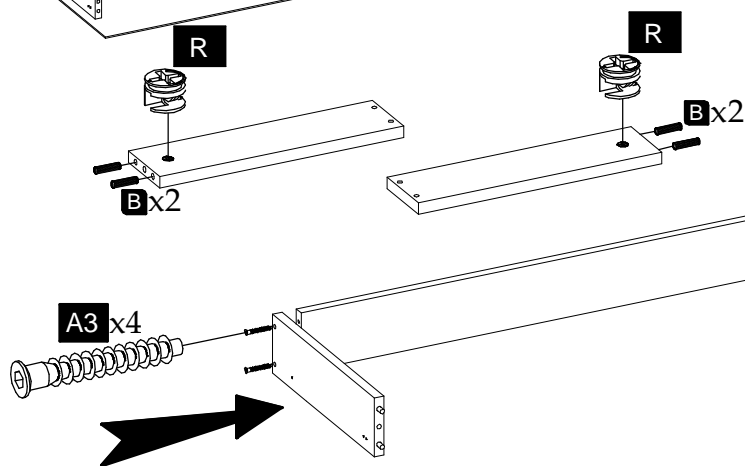
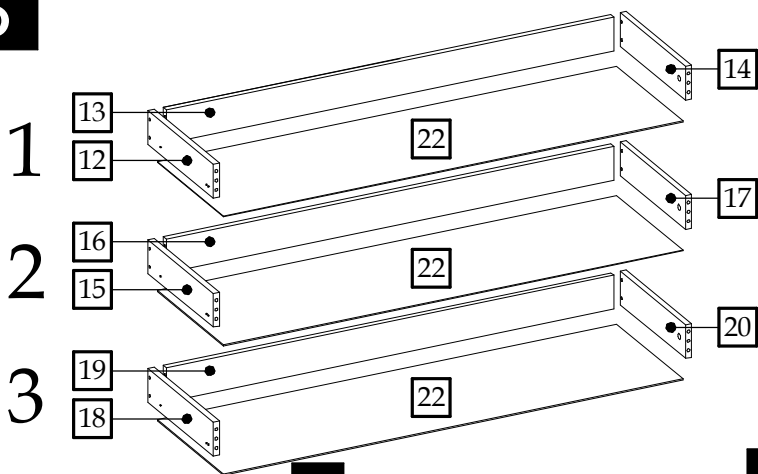

U x2

