

SPLIT

Typ R

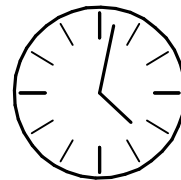

40 min

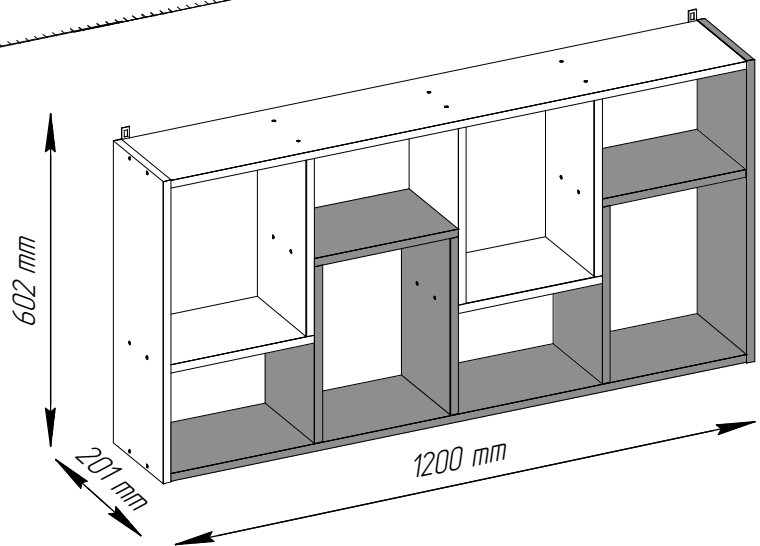
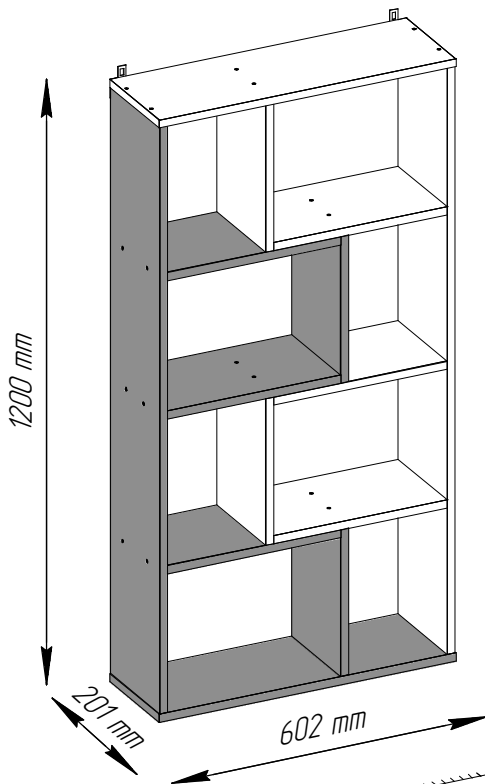
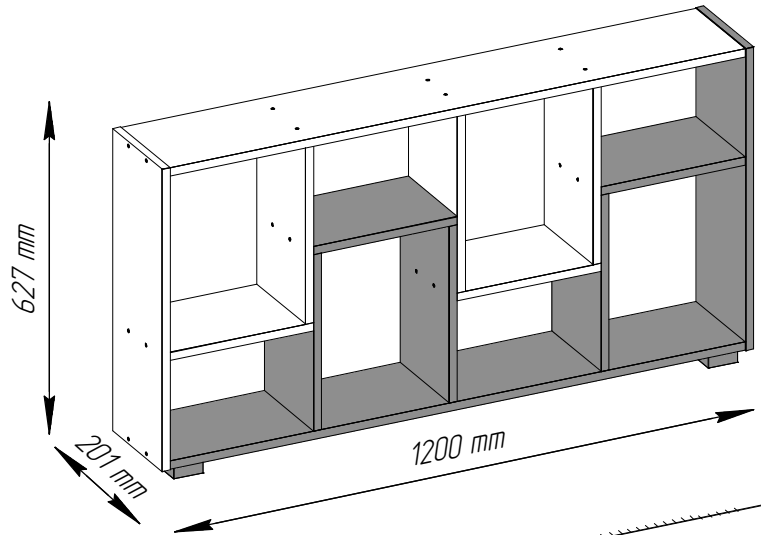
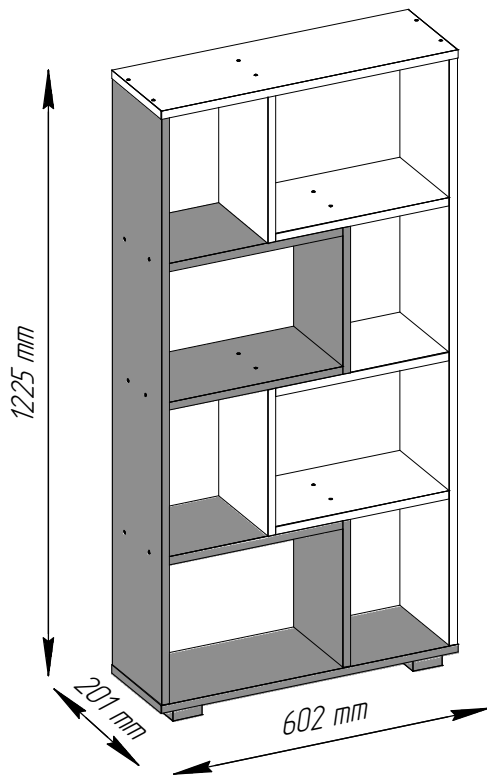
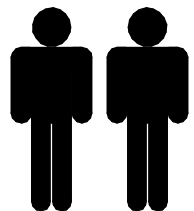

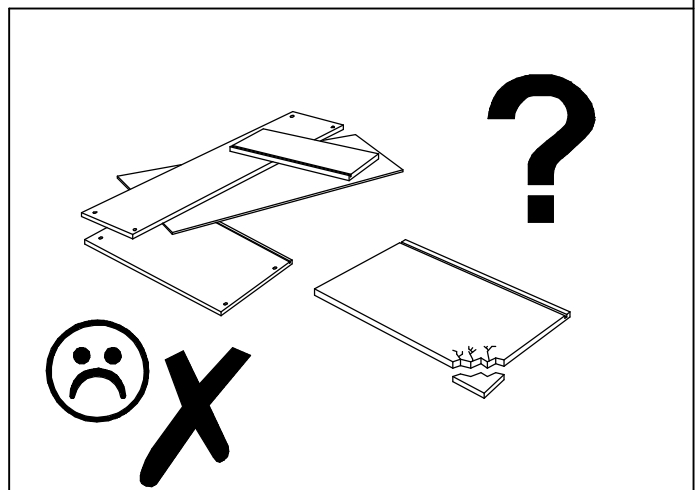
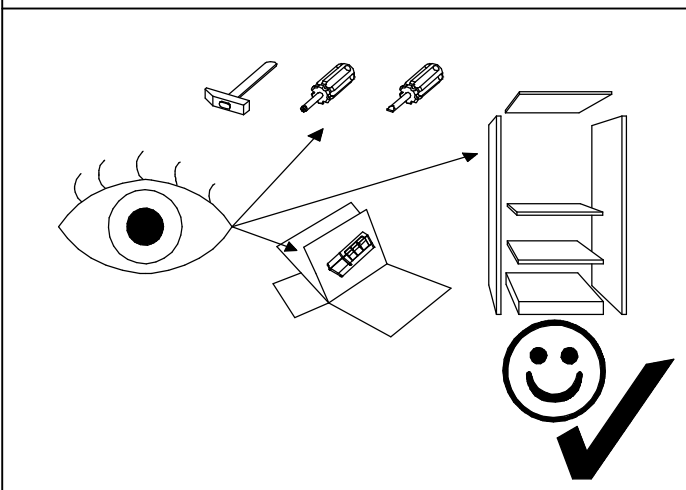
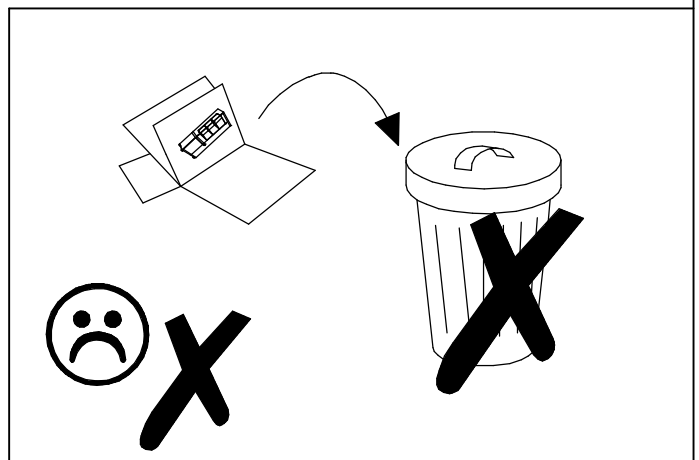
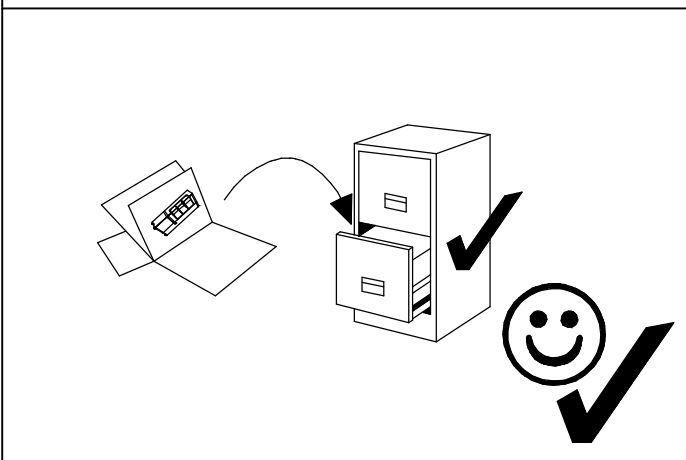
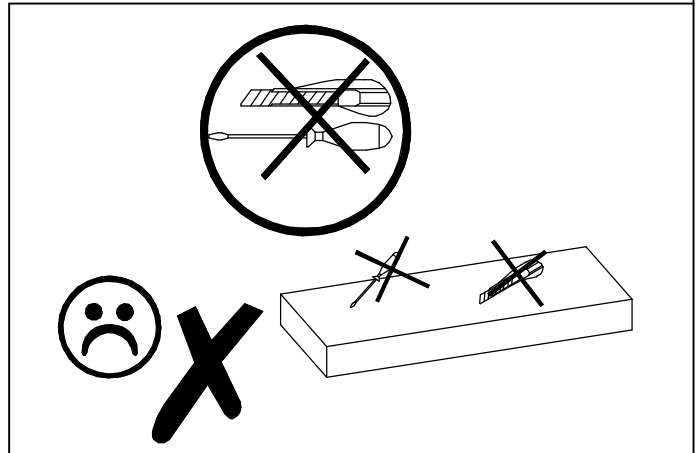
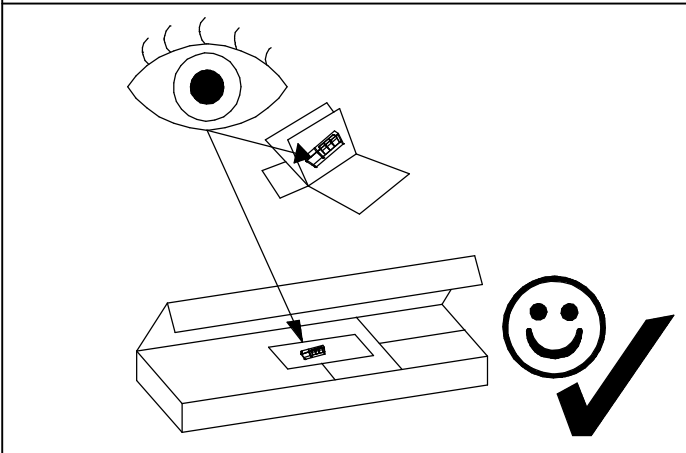

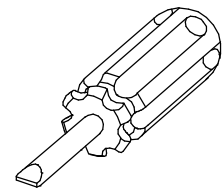
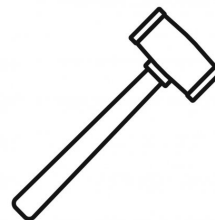
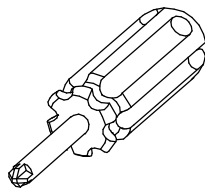
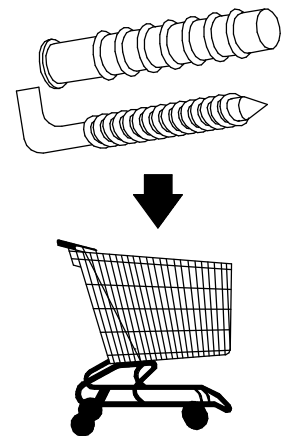
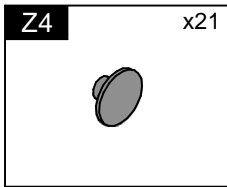
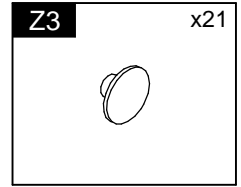
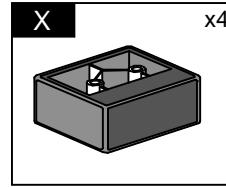
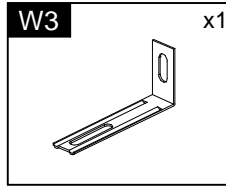
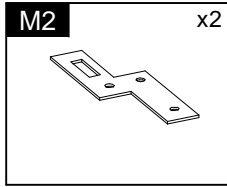
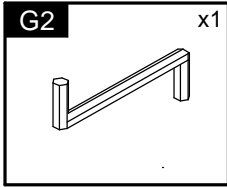
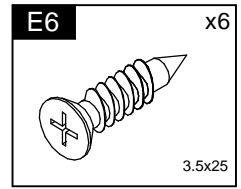
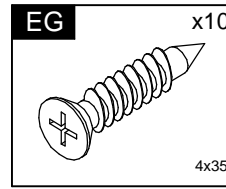
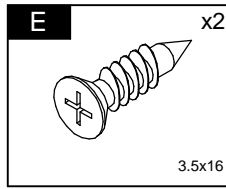
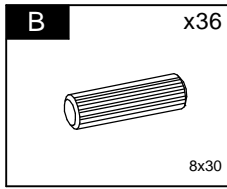
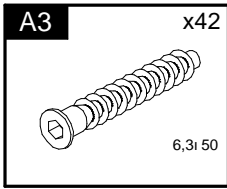
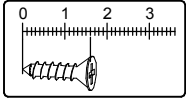

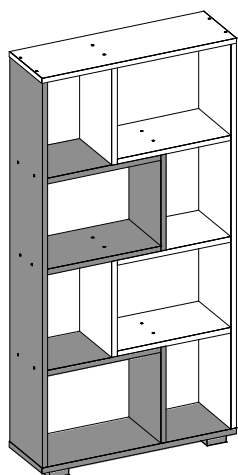

Element symbol	Measurements				Code	Paket
1	1168	200	16	1	1003	
2	602	201	16	1	1004	
3	292	199	16	2	1006	
4	352	199	16	2	1007	
5	352	199	16	1	1011	
6	292	199	16	2	1013	
7	352	199	16	2	1014	
8	1168	200	16	1	1002	
9	352	199	16	1	1009	
10	602	201	16	1	1005	

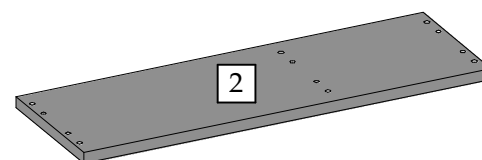
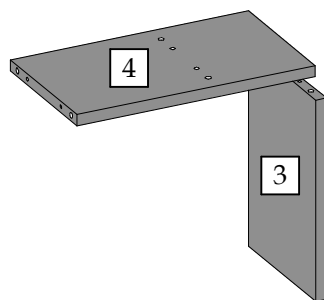
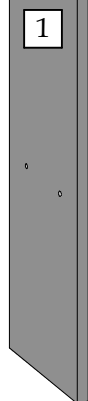
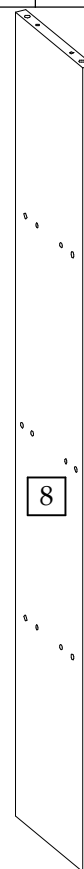
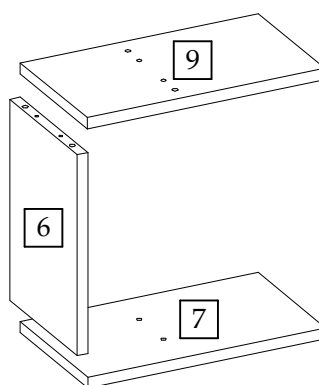
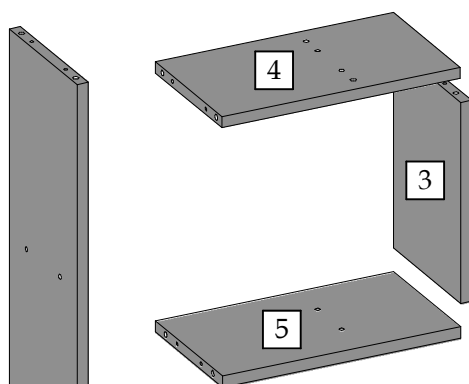
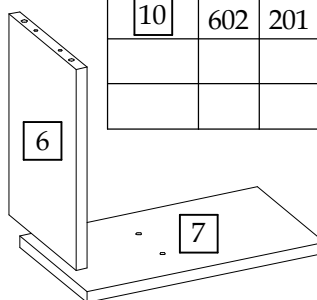
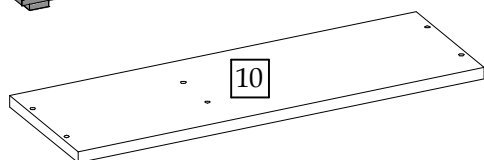

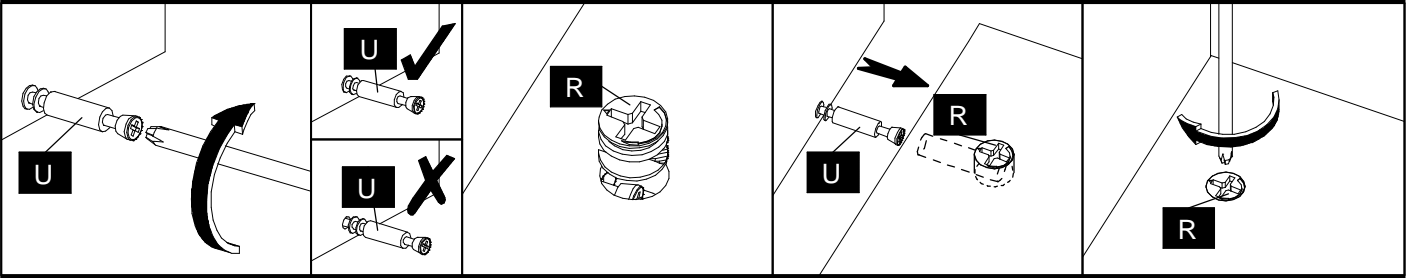

1

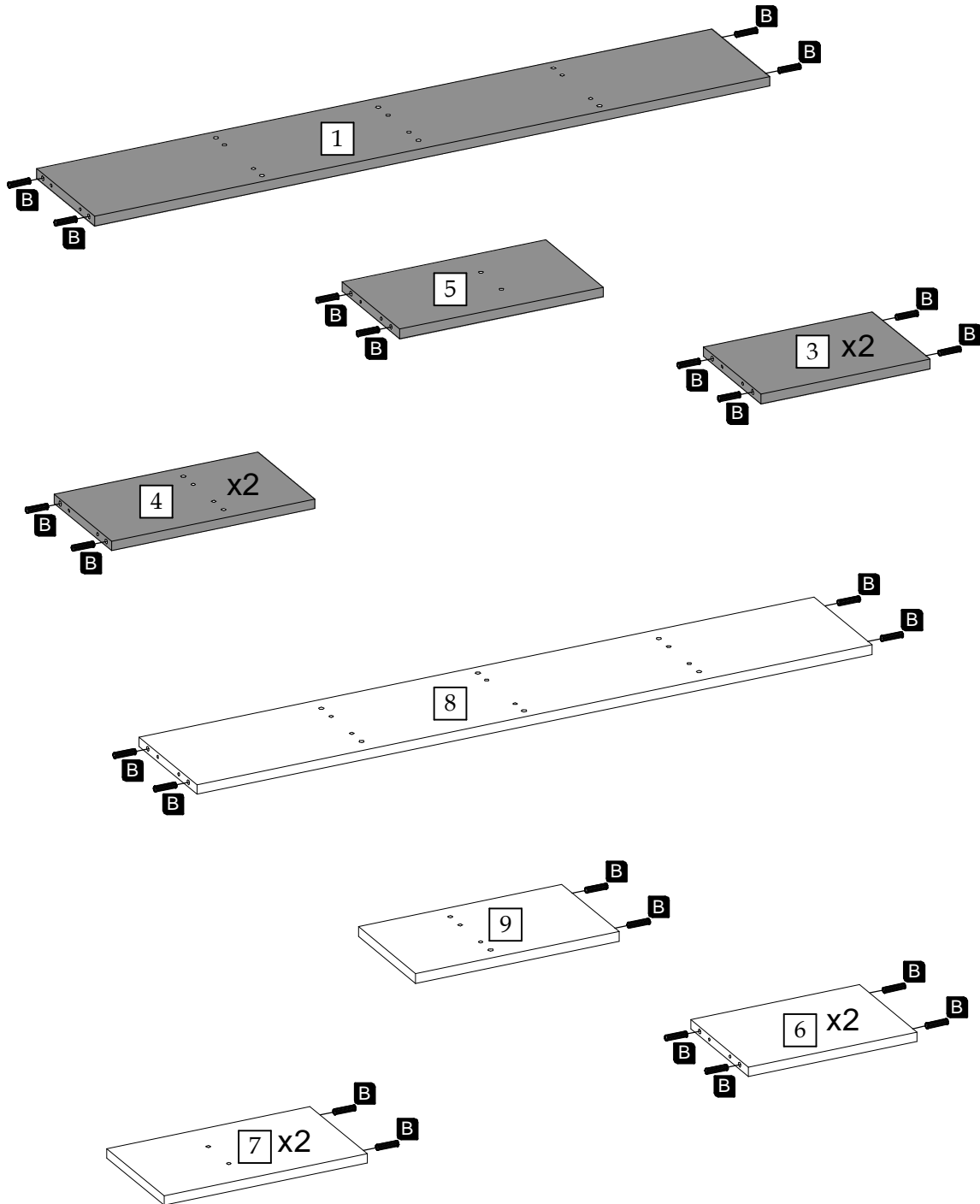

2

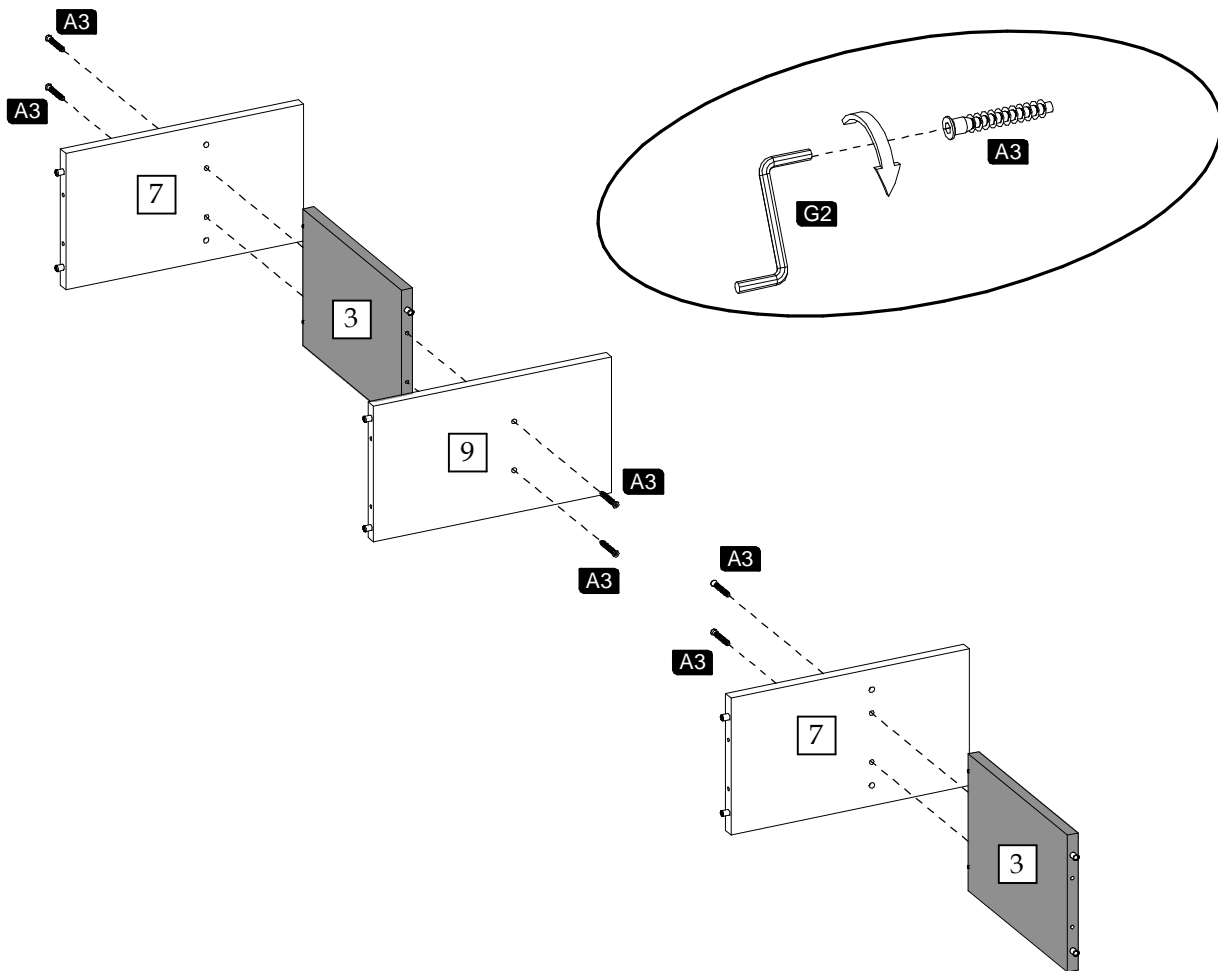

3

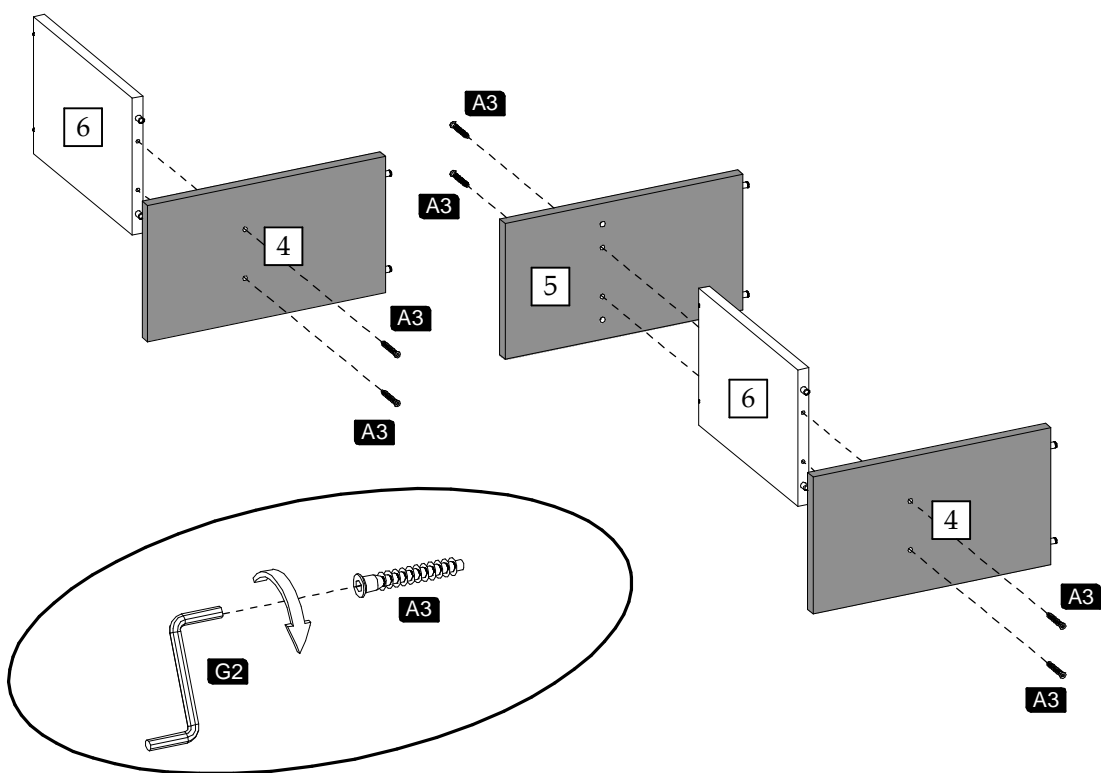

4

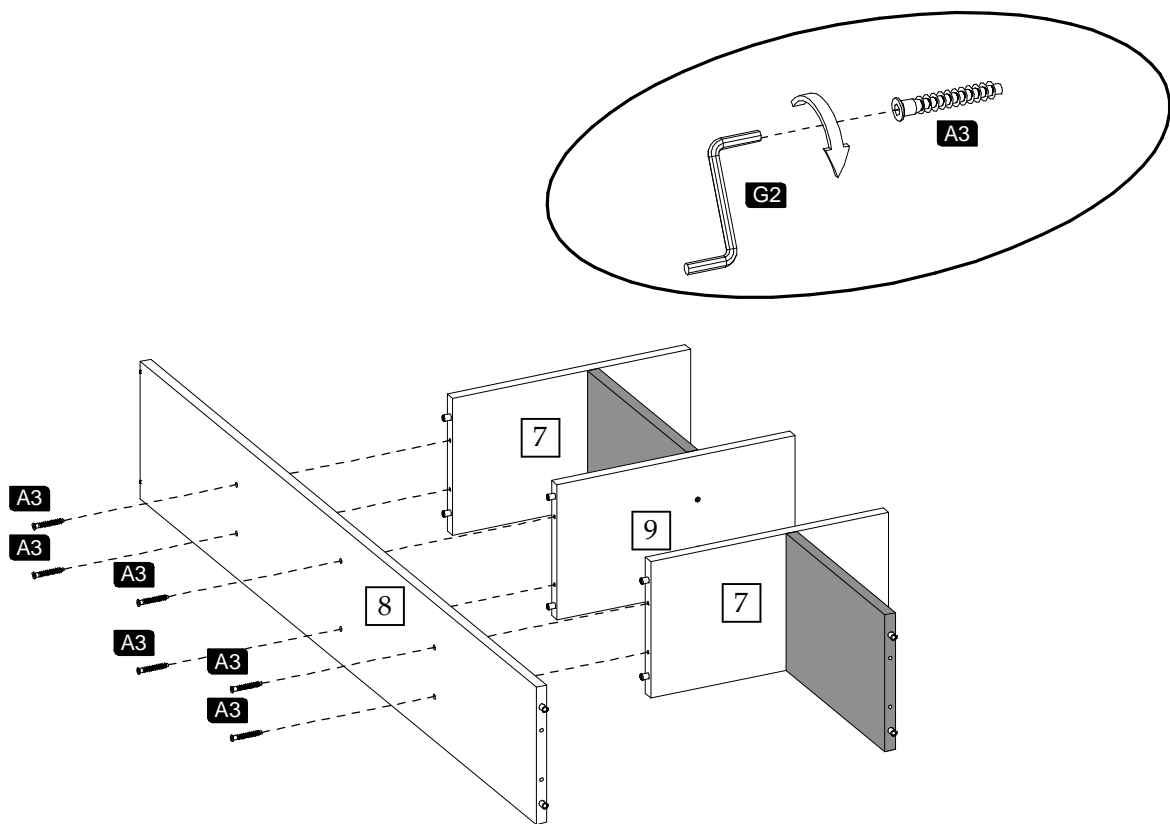

5

